

All copper, Skive Fin Technology

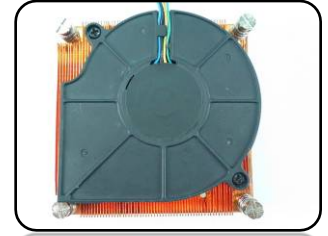

Top View

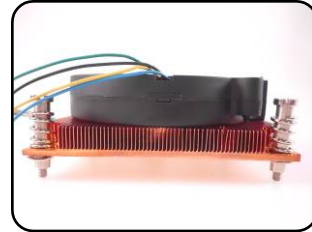

Side View

Product Specification

Application Socket	Intel LGA 115X
Heat Sink Dimension	84mm X 84mm X 12mm
Heat Sink Material	Copper
Fan Dimension	Φ75 X 15
Bearing Type	2Ball Bearing Fan Life Expectancy at 40°C 50000HR
Fan Speed (RPM)	1000±400rpm~5500±10%
Fan Airflow (CFM)	11.83 Max
Static Pressure (mm H2O)	20.66 Max
Fan Noise Level (dBA)	<56
Rated Voltage (V)	12
Weight (g)	380

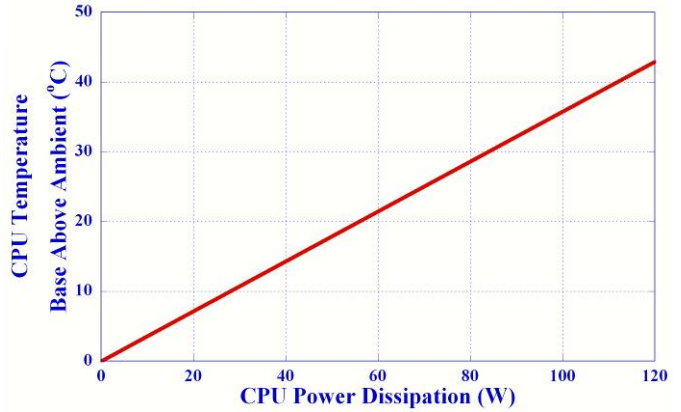

Features:

- Max TDP 95W(Up To System Fan)
- All Copper Provides Faster Heat Dissipation Rate
- Design For 1U Server
- PWM Function Fan for a Silent Operation

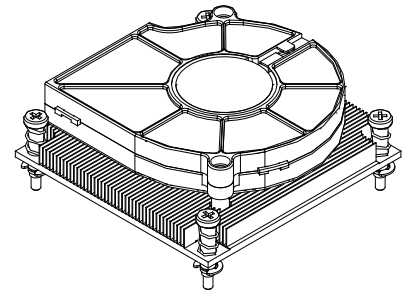
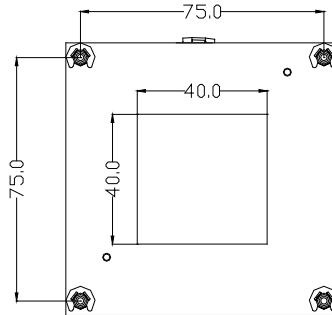
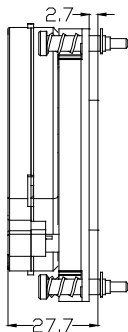
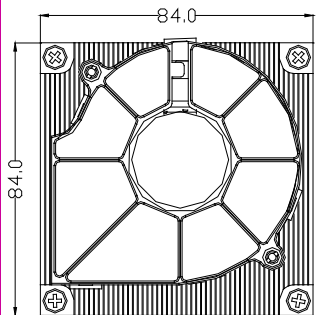

Unit : mm